

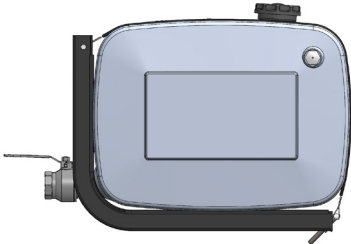

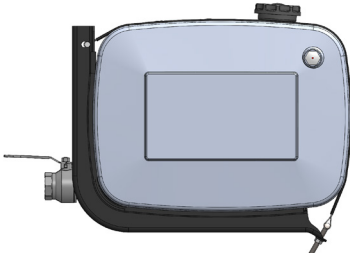
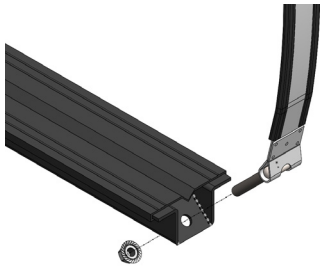

Fixing kit for tanks

With the goal of constantly improving the quality of our products and their alignment to the technical equipment of the current ranges of industrial vehicles, we inform you that the fixing kits of the side oil and diesel tanks “JOLLY P” and “BP” will be suspended and replaced with new fixing kits that have the following advantages:

WAS	WILL BE
	<p>Better coupling tank/fixing kit.</p> 
	<p>Improved support profile to allow a smooth fitting.</p> 
	<p>Self-locking pin instead of screw+nut. Allows a reduction in assembly time.</p> 
	<p>Unified mounting kit for all lengths (version with back recesses no longer required).</p> 

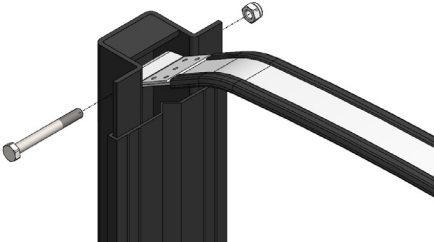
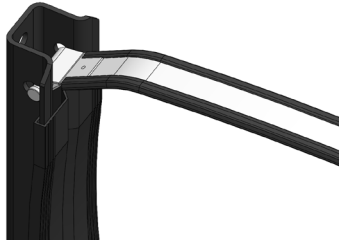
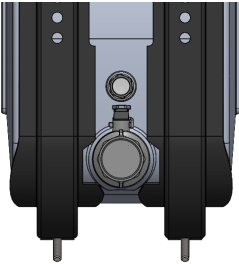
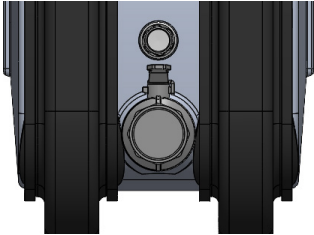
OIL TANKS - range JOLLY P (480x650)		
CURRENT code	Description	New code
135903BPLX0	Fixing kit with stainless steel straps	135903BPLX6
135903BPLX1*		
* version with back recesses no longer required		

WAS
135903BPLX0-135903BPLX1

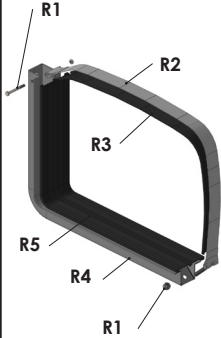
		Spare parts	
	R1	13590105036	Screws and nuts kit
	R2	538200BP1X0	Stainless steel strap for tank
	R3	50620000601	Protection for oil tank strap
	R4	538205BPLG0	Mounting brackets 135903BPLX0
		538205BPLG5	Mounting brackets RIGHT - 135903BPLX1
R5	50620000306	Rubber protection	

WILL BE
135903BPLX6

		Spare parts	
	R1	538200BP1X1	Stainless steel strap for tank
	R2	50620000609	Protection for oil tank strap
	R3	50620000801	Rubber protection
	R4	538205BPLG6	Mounting brackets
	R5	13590105125	Pin and nut kit for mounting kit

FUEL TANKS - range BP (480x650)		
CURRENT code	Description	New code
135903BPLX2	2 Fixing kit with stainless steel straps	135903BPLX6
135903BPLX3	3 Fixing kit with stainless steel straps	135903BPLX7
135903BPLG2	2 Fixing kit with coated steel straps	135903BPLG6
135903BPLG3	3 Fixing kit with coated steel straps	135903BPLG7

WAS

135903BPLX2-135903BPLX3

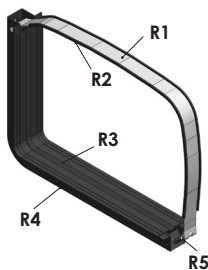
Spare parts			
	R1	538200BP1X0	Stainless steel strap for tank
	R2	50620000601	Protection for oil tank strap
	R3	50620000306	Rubber protection
	R4	538205BPLG0	Mounting brackets
	R5	13590105036	Screws and nuts kit

WILL BE

135903BPLX6-135903BPLX7

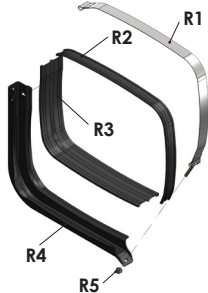
Spare parts			
	R1	538200BP1X1	Stainless steel strap for tank
	R2	50620000609	Protection for oil tank strap
	R3	50620000801	Rubber protection
	R4	538205BPLG6	Mounting brackets
	R5	13590105125	Pin and nut kit for mounting kit

WAS

135903BPLG2-135903BPLG3

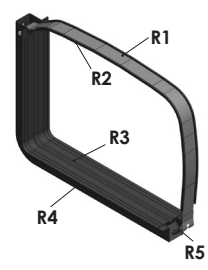
Spare parts			
	R1	538200BP1G0	Stainless steel strap for tank
	R2	50620000100	Protection for oil tank strap
	R3	50620000306	Rubber protection
	R4	538205BPLG0	Mounting brackets
	R5	13590105036	Screws and nuts kit

WILL BE

135903BPLG6-135903BPLG7

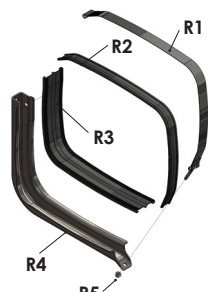
Spare parts			
	R1	538200BP1G1	Stainless steel strap for tank
	R2	50620000609	Protection for oil tank strap
	R3	50620000801	Rubber protection
	R4	538205BPLG6	Mounting brackets
	R5	13590105125	Pin and nut kit for mounting kit